





SCANIA 4 Serija



5001097 4001188	Scania 4 09/95>09/04 priekinis žibintas d.p.	
5001421 4001189	Scania 4 09/95>09/04 priekinis žibintas k.p.	
5002800 5008166	Scania 4 09/95>09/04 priekinio žibinto stiklas d.p.	
5008144	Scania 4 09/95>09/04 priekinio žibinto stiklas k.p.	

4001081 5001442	Scania 4 09/95>09/04 posūkis d.p.	
4001011	Scania 4 09/95>09/04 k.p.	
5005373	Lizdas, posūkio SC-124	
5000687 5008583	Scania 4 09/95>09/04 priešrūkinis žibintas d.p.	
5001454 5008582	Scania 4 09/95>09/04 priešrūkinis žibintas k.p.	
5003519	Scania 4 09/95>09/04 priešrūkinio žibinto stiklas k=d	
5005598	Lemputės H1 lizdas SC-4	
5002595	Žib.diodinis LP-10 Scania su laidu	
5005681	Atšvaitas Scania	
5005879	Žib.atšvaitas MD-10 Scania su lizdu į laipto vidurinę apdailą	
5003200	Žibintas gabaritinis Scania 4 k=d	
5005878	Scania 4 96> buferio centrinė dalis	

5005615	Scania 4 96> buferio kampas d.p.	
5005614	Scania 4 96> buferio kampas k.p.	
5005880	Scania 4 96>05 buferis metalinis	
5005881	Scania 4 96> buferio baltis	
5005580	Scania 4 96> žibinto rėmas (kampas) d.p.	
5006949	Scania 4 96> žibinto rėmas (kampas) k.p.	
5006089	Scania 4 96> apatinės grotelės	
1306404	Scania 4 96> apatinių grotelių lankstas d.p.	
1306403	Scania 4 96> apatinių grotelių lankstas k.p.	
1515194	Scania 4 96> laipto korpusas d.p	
1515195	Scania 4 96> laipto korpusas k.p	
1426110	Scania R 05> laipto korpuso kronšteinas d.p.	

1426109	Scania R 05> laipto korpuso kronšteinas k.p.	
5005597	Scania 4 96> laiptelių viršutinė apdaila d.p.	
5000435	Scania 4 96> laiptelių viršutinė apdaila k.p.	
5005596	Scania 4 96> laiptelių vidurinė apdaila d.p.	
5008857	Scania 4 96> laiptelių vidurinė apdaila k.p.	
5008858	Scania 4 96>05 pakoja apatinė k=d	
4001716	Scania 4 96>05 pakoja vidurinė k=d	
5006164	Scania 4 96> kapotas (centrinės grotelės) žemai kabinai	
1401931	Scania 4 96> grotelės į kapotą viršutinės žemai kabinai	
1371754	Scania 4 96> grotelės į kapotą apatinės žemai kabinai	
5006088	Scania 4 96> kapotas (centrinės grotelės)	

1401929	Scania 4 96> grotelēs ī kapotā viršutinēs, 161CM	
1371757	Scania 4 96> grotelēs ī kapotā vidurinės, 157CM	
1371758	Scania 4 96> grotelēs ī kapotā apatinēs, 154CM	
1383610	Scania 4 96> apdailos virš kapoto rēmas	
1383609	Scania 4 96> apdaila virš kapoto	
1375428	Scania 4 96> priekinio žibinto apdaila d.p.	
1375427	Scania 4 96> priekinio žibinto apdaila k.p.	
1427429	Scania 4 96> panelēs virš kapoto vidinė dalis d.p.	
5009905	Scania 4 96> panelēs virš kapoto vidinė dalis k.p.	
4001196	Scania 4 96> kabinos kampo lankstas d.p.	
4001195	Scania 4 96> kabinos kampo lankstas k.p.	
5006034	Scania 4 96> kabinos kampas (oro nukreipējas) d.p.	
5008859	Scania 4 96> kabinos kampas (oro nukreipējas) k.p.	
1386958	Scania 4 96> kabinos kampas (žema kabina) d.p.	
1386957	Scania 4 96> kabinos kampas (žema kabina) k.p.	

5008860	Scania 4 96> kabinos kampo vidinė dalis d.p.	
5008861	Scania 4 96> kabinos kampo vidinė dalis k.p.	
1386960	Scania 4 96> kabinos kampo vidinė dalis žemai kabinai d.p.	
5006157	Scania 4 96> kabinos kampo vidinė dalis žemai kabinai k.p.	
1382728	Scania 4 96> kabinos kampo apdaila maža d.p.	
1382727	Scania 4 96> kabinos kampo apdaila maža k.p.	
1370108	Scania 4 96> kabinos kampo apdaila maža žemai kabinai d.p.	
1370107	Scania 4 96> kabinos kampo apdaila maža žemai kabinai k.p.	
5007221	Scania 4 96> kabinos posparnio išorinė dalis d.p. 100mm aukštis	
5007222	Scania 4 96> kabinos posparnio išorinė dalis k.p. 100mm aukštis	
5009947	Scania R 05> priekinio posparnio galinė apdaila d.p. 415mm aukštis	
5009948	Scania R 05> priekinio posparnio galinė apdaila k.p. 415mm aukštis	



5009967	Scania R 05> priekinio posparnio galinė apdaila d.p. 350mm aukštis	
5009968	Scania R 05> priekinio posparnio galinė apdaila k.p. 350mm aukštis	
5009949	Laikiklis Scania 4/P/R/G/2010 priekio sparno d/k	
5005582	Scania 4 96> kabinos posparnis priekinis d.p. galinis k.p	
5006028	Scania 4 96> kabinos posparnis priekinis k.p. galinis d.p	
5003178	Scania 4 96> durų rankenėlė d.p.	
5003177	Scania 4 96> durų rankenėlė k.p.	
5003688	Scania 4 96> durų rankenėlės šerdis su rakteliu	
5009953	Scania 4/P/R/G dangtelis vyrio ant kėbulo d.p.	

5009953	Scania 4/P/R/G dangtelis vyro ant kėbulo k.p.	
5009955	Scania 4/P/R/G dangtelis vyro ant durų d.p.	
5009956	Scania 4/P/R/G dangtelis vyro ant durų k.p.	
5009432	Scania 4 96-04 vidinė rankenėlė k.p.	
4000492	Scania 4 96-04 vidinė rankenėlė d.p.	
5009978	Scania 4 96> apdaila už kabinos prie kuro bako k=d	
0000582	Scania 4 96> akumuliatoriaus dangtis	
5008260	Scania 4 96> saulės skydelio skaidri dalis	
1539870	Scania 4 96> saulės skydelio viršutinė dalis su skylė priešrūkiniui	

1539871	Scania 4 96> saulės skydelio viršutinė dalis be skylės priešrūkiniam	
1326953	Scania 4 96> dangtelis į saulės skydelį	
5003390	Scania 4 96> žibintas į saulės skydelį	
5003496	Scania 4 96> galinio sparno išorinė k.p.=vidinė d.p.	
5001801	dalis Scania 4 96> galinio sparno išorinė d.p.=vidinė k.p. dalis	
5003967	Scania 4 96> galinio sparno viršutinė dalis	
5005599	Scania 4 96> galinio sparno viršutinė dalis autovežiui	
5009969	Scania 4 96> laikiklis žibintui	
5005575	Scania 4 96> galinio sparno kronšteinas d.p. priekinis	
5006587	Scania 4 96> galinio sparno kronšteinas k.p. priekinis	
5007322	Scania 4 96> galinio sparno kronšteinas d.p. 792mm M16x2	

5007323	Scania 4 96> galinio sparno kronšteinas k.p. 792mm	 <p>A black metal cross member for the rear wing of a Scania 4 96 truck. It has a curved shape with a mounting bracket on one end. A red dimension line above it indicates a length of 792mm.</p>
5005276	Laikiklis sparnui galinis d.p. M16*2,0 Scania	 <p>A black metal support bracket for the rear wing. It has a curved shape with a mounting bracket on one end and several holes for bolts.</p>
5008575	Laikiklis sparnui galinis k.p. M16*2,0 Scania	 <p>A black metal support bracket for the rear wing, similar to the previous one but with a different mounting bracket on the other end.</p>
4002324	Kronšteinas laikiklio sparno tvirtinimo SC	 <p>A black metal support bracket for the wing. It has a curved shape with four holes for bolts on the sides.</p>
5008645	Įvorė laikiklio sparno SC	 <p>A black metal sleeve for the wing support. It has a cylindrical shape with a flange on one end and a smaller diameter section on the other.</p>
5009498	Scania 4 96> sparno laikiklio skarda	 <p>A black metal shield for the wing support. It has a curved shape with several holes and a red mark on the side.</p>

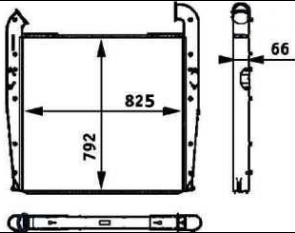
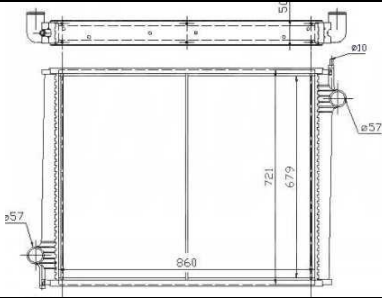





5009499	Scania 4 96> sparno laikiklio skarda	
5003687	Scania 4 96> galinio sparno guminis laikiklis	
5005595	Scania 4 96> galinio sparno metalinis laikiklis	
5003306	Bako kamštis SCANIA su užraktu	
5005581	Scania 4 96> oro filtro dėžė	
1390706	Scania 4 96> ventiliatoriaus difuzorius (R94,114)	
5006705	Scania 4 96> ventiliatoriaus difuzorius (CR124), 95*8	
5006873	Scania 4 96> vandens radiatorius 860x918x42 (M/A,+/-AC)	









5009060	Scania 4 96> intercooler radiatorus 825x792x66	
1145003	Scania 4 96>00 vandens radiatorius 860x679x50 (M/A,+/AC)	
5005050 5009684	Scania 4 96> išsiplėimo bakelis	
1393424	Scania 4 96> sparnuotė 750mm	

SCANIA R 5serija



5001097 4001188	Scania 4 09/95>09/04 priekinis žibintas d.p.	
5001421 4001189	Scania 4 09/95>09/04 priekinis žibintas k.p.	
5002800 5008166	Scania 4 09/95>09/04 priekinio žibinto stiklas d.p.	
5002057 5008144	Scania 4 09/95>09/04 priekinio žibinto stiklas k.p.	
5001442 4001081	Scania 4 09/95>09/04 posūkis d.p.	
4001011	Scania 4 09/95>09/04 k.p.	
5005373	Lizdas, posūkio SC-124	

5005882	Scania R/P/T 05> priekinis žibintas Xenon d.p.	
5005883	Scania R/P/T 05> priekinis žibintas Xenon k.p.	
5005720	Scania R/P/T 05> priekinio žibinto stiklas Xenon d.p.	
5005719	Scania R/P/T 05> priekinio žibinto stiklas Xenon k.p.	
5003742	Scania R/P/T 05> posūkis d=k	
5003090	Scania P/R/T 03/04> tolimų šviesų žibintas d.p.	
5003091	Scania P/R/T 03/04> tolimų šviesų žibintas k.p.	
5002879	Scania P/R/T 03/04> priešrūkinis žibintas d.p.	
5001334	Scania P/R/T 03/04> priešrūkinis žibintas k.p.	
5006055	Scania P/R/T 03/04> žibintas DRL d.p.	
4000643	Scania P/R/T 03/04> žibintas DRL d.p.	

5002595	Žib.diodinis LP-10 Scania su laidu	
5005681	Atšvaitas Scania	
5005879	Žib.atšvaitas MD-10 Scania su lizdu į laipto vidurinę apdailą	
5003200	Žib.diodinis LP-10 SCANIA (3LED)	
5004887	Scania R/P/T 05> posūkis d=k	
5005717	Scania R 05> žibintas diodinis į saulės skydelį (su laidu)	
4000156		
5004887	Scania R/P/T 05> posūkis d=k	
5005884	Scania R 05> buferio centrinė dalis	
1495578	Scania R 05> grotelės į centrinę buferio dalį d.p.	
1495577	Scania R 05> grotelės į centrinę buferio dalį k.p.	
5005885	Scania R 05> buferio kampinė dalis d.p.	

5005886	Scania R 05> buferio kampinė dalis k.p.	
1422843	Scania R 05> buferio balkis	
5005887	Scania P 05> buferio kampinė dalis d.p.	
5005888	Scania P 05> buferio kampinė dalis k.p.	
5009768	Scania R 05> priešrūkinio žibinto rėmelis d.p.	
5009771	Scania R 05> priešrūkinio žibinto rėmelis k.p.	
5008755	Scania R 05> priešrūkinio žibinto dangtelis išorinis k=d	
5008754	Scania R 05> priešrūkinio žibinto dangtelis vidinis k=d	
5006957	Scania R 05> žibinto korpuso II dalis d.p.	
5006968	Scania R 05> žibinto korpuso II dalis k.p.	

1727992	Scania R 05> žibinto korpuso I dalis d.p.	
1727991	Scania R 05> žibinto korpuso I dalis k.p.	
5008869	Scania R 05> žib.korpuso virš.dalis (R/T kab) d.p.	
5008870	Scania R 05> žib.korpuso virš.dalis (R/T kab) k.p.	
5009962	Scania R 05> laipto korpusas d.p.	
5009963	Scania R 05> laipto korpusas k.p.	
1426110	Scania R 05> laipto korpuso kronšteinas d.p.	
1426109	Scania R 05> laipto korpuso kronšteinas k.p.	
5009976	Scania R 05> laipto apdaila viršutinė d.p. platus kantas 100mm	
5009961	Scania R 05> laipto apdaila viršutinė k.p. platus kantas 100mm	

5009959	Scania R 05> laipto apdaila viršutinė d.p. siauras kantas 50mm	
5009960	Scania R 05> laipto apdaila viršutinė k.p. siauras kantas 50mm	
5009348	Scania R 05> laipto apdaila apatinė d.p.	
5009347	Scania R 05> laipto apdaila apatinė k.p.	
5008190	Scania R 05> laipto apdaila vidurinė d.p. NAUJO TIPO	
5002239	Scania R 05> laipto apdaila vidurinė k.p. NAUJO TIPO	
5009974	Scania R 05> laipto apdaila vidurinė k.p. lygi	
1535039	Scania R 05> pakoja viršutinė d.p.	
1535040	Scania R 05> pakoja viršutinė k.p.	
5009964	Scania R 05> pakoja vidurinė k=d	

5008140	Scania R 05> pakoja apatinė k=d	
5009971	Scania R 05> apatinės grotelės	
5009972	Scania R 05> viršutinės grotelės į apatines groteles	
5009973	Scania R 05> apatinės grotelės į apatines groteles	
1748085	Scania R 05> grotelių apdaila po kapotu	
1459145	Scania R 05> grotelės po kapotu	
1538383	Scania R 05> kapotas	
1459135	Scania R 05> grotelės į kapotą apatinės	
1459134	Scania R 05> grotelės į kapotą vidurinės	
1459133	Scania R 05> grotelės į kapotą viršutinės	
1466032	Scania R 05> grotelės į kapotą kampinės d.p.	
1466031	Scania R 05> grotelės į kapotą kampinės k.p.	

1804628	Scania R 05> kapoto rēmas	
5008862	Scania R 05> kabinos kampo apdaila d.p.	
5008863	Scania R 05> kabinos kampo apdaila k.p.	
5008864	Scania R 05> kabinos kampo vidinė dalis d.p.	
5008865	Scania R 05> kabinos kampo vidinė dalis k.p.	
5004381	Scania R 05> kabinos pakēlimo cilindras	
5003178	Scania 4 96> durų rankenėlė d.p.	
5003177	Scania 4 96> durų rankenėlė k.p.	
5003688	Scania 4 96> durų rankenėlės šerdis su rakteliu	
5009953	Scania 4/P/R/G dangtelis vyro ant kėbulo d.p.	
5009953	Scania 4/P/R/G dangtelis vyro ant kėbulo k.p.	

5009955	Scania 4/P/R/G dangtelis vyro ant durų d.p.	
5009956	Scania 4/P/R/G dangtelis vyro ant durų k.p.	
5009947	Scania R 05> priekinio posparnio galinė apdaila d.p. 415mm aukštis	
5009948	Scania R 05> priekinio posparnio galinė apdaila k.p. 415mm aukštis	
5009967	Scania R 05> priekinio posparnio galinė apdaila d.p. 350mm aukštis	
5009968	Scania R 05> priekinio posparnio galinė apdaila k.p. 350mm aukštis	
5009949	Laikiklis Scania 4/P/R/G/2010 priekio sparno d/k	

5009965	Scania R 05> priekinio posparnio priekinė apdaila d.p. 165mm aukštis	
5009966	Scania R 05> priekinio posparnio priekinė apdaila k.p.	
5005582	Scania 4 96> kabinos posparnis priekinis d.p. galinis k.p	
5006028	Scania 4 96> kabinos posparnis priekinis k.p. galinis d.p	
0000582	Scania 4 96> akumuliatoriaus dangtis	
5009978	Scania 4 96> apdaila už kabinos prie kuro bako k=d	
5008260	Scania 4 96> saulės skydelio skaidri dalis	
1539870	Scania 4 96> saulės skydelio viršutinė dalis su skylė priešrūkiniui	
1539871	Scania 4 96> saulės skydelio viršutinė dalis be skylės priešrūkiniam	
1326953	Scania 4 96> dangtelis į saulės skydelį	
5003390	Scania 4 96> žibintas į saulės skydelį	

5003496	Scania 4 96> galinio sparno išorinė k.p.=vidinė d.p.	
5001801	dalis Scania 4 96> galinio sparno išorinė d.p.=vidinė k.p. dalis	
5003967	Scania 4 96> galinio sparno viršutinė dalis	
5005599	Scania 4 96> galinio sparno viršutinė dalis autovežiui	
5009969	Scania 4 96> laikiklis žibintui	
4000792	Scania R 05> galinio sparno kronšteinas d.p.	
4000793	Scania R 05> galinio sparno kronšteinas k.p.	
4001444	Scania R 05> priekinio sparno kronšteinas d.p.	
4001445	Scania R 05> priekinio sparno kronšteinas k.p.	
5005276	Laikiklis sparnui galinis d.p. M16*2,0 Scania	

5008575	Laikiklis sparnui galinis k.p. M16*2,0 Scania	
4002324	Kronšteinas laikiklio sparno tvirtinimo SC	
5008645	Įvorė laikiklio sparno SC	
5009498	Scania 4 96> sparno laikiklio skarda	
5009499	Scania 4 96> sparno laikiklio skarda	
5003687	Scania 4 96> galinio sparno guminis laikiklis	









5003306	Bako kamštis SCANIA su užraktu	
5005889	Scania R 05> bėgių perjungimo svirties rankenėlė	
5009061	Scania R 05> intercooler radiatorus 885x762x63	
5009072	Scania R 05> vandens radiatorius 860x940x42 (M/A,+/-AC)	
5005050 5009684	Scania 4 96> išsiplėtimo bakelis	

SCANIA P 05> -Serija









5001097 4001188	Scania 4 09/95>09/04 priekinis žibintas d.p.	
5001421 4001189	Scania 4 09/95>09/04 priekinis žibintas k.p.	
5002800	Scania 4 09/95>09/04 priekinio žibinto stiklas d.p.	
5002057 5008144	Scania 4 09/95>09/04 priekinio žibinto stiklas k.p.	
5001442 4001081	Scania 4 09/95>09/04 posūkis d.p.	
4001011	Scania 4 09/95>09/04 posūkis k.p.	
5005373	Lizdas, posūkio SC-124	

5005882	Scania R/P/T 05> priekinis žibintas Xenon d.p.	
5005883	Scania R/P/T 05> priekinis žibintas Xenon k.p.	
5005720	Scania R/P/T 05> priekinio žibinto stiklas Xenon d.p.	
5005719	Scania R/P/T 05> priekinio žibinto stiklas Xenon k.p.	
5003742	Scania R/P/T 05> posūkis d=k	
5006055	Scania P/R/T 03/04> žibintas DRL d.p.	
4000643	Scania P/R/T 03/04> žibintas DRL d.p.	
5003090	Scania P/R/T 03/04> tolimų šviesų žibintas d.p.	
5003091	Scania P/R/T 03/04> tolimų šviesų žibintas k.p.	
5002879	Scania P/R/T 03/04> priešrūkinis žibintas d.p.	
5001334	Scania P/R/T 03/04> priešrūkinis žibintas k.p.	

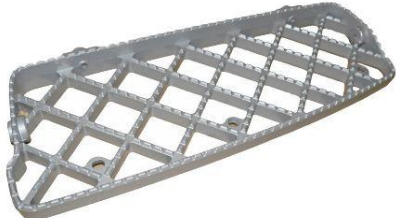
5002595	Žib.diodinis LP-10 Scania su laidu	
5005681	Atšvaitas Scania	
5005879	Žib.atšvaitas MD-10 Scania su lizdu į laipto vidurinę apdailą	
5003200	Žib.diodinis LP-10 SCANIA (3LED)	
5004887	Scania R/P/T 05> posūkis d=k	
5005717	Scania R 05> žibintas diodinis į saulės skydelį	
4000156 (su laidu)		
5005884	Scania R 05> buferio centrinė dalis	
1495578	Scania R 05> grotelės į centrinę buferio dalį d.p.	
1495577	Scania R 05> grotelės į centrinę buferio dalį k.p.	
422843	Scania R 05> buferio balkis	



5005887	Scania P 05> buferio kampinė dalis d.p.	
5005888	Scania P 05> buferio kampinė dalis k.p.	
5009768	Scania R 05> priešrūkinio žibinto rėmelis d.p.	
5009771	Scania R 05> priešrūkinio žibinto rėmelis k.p.	
5008755	Scania R 05> priešrūkinio žibinto dangtelis išorinis k=d	
5008754	Scania R 05> priešrūkinio žibinto dangtelis vidinis k=d	
1431921	Scania R 05> žibinto korpuso II dalis d.p.	
1431920	Scania R 05> žibinto korpuso II dalis k.p.	
1727992	Scania R 05> žibinto korpuso I dalis d.p.	
1727991	Scania R 05> žibinto korpuso I dalis k.p.	
5008871	Scania P 05> žib.korpuso virš.žema kabina d.p.	
5008872	Scania P 05> žib.korpuso virš.dalis žema kabina k.p.	
5009962	Scania R 05> laipto korpusas d.p.	
5009963	Scania R 05> laipto korpusas k.p.	

1426110	Scania R 05> laipto korpuso kronšteinas d.p.	
1426109	Scania R 05> laipto korpuso kronšteinas k.p.	
5009976	Scania R 05> laipto apdaila viršutinė d.p. platus kantas 100mm	
5009961	Scania R 05> laipto apdaila viršutinė k.p. platus kantas 100mm	
5009959	Scania R 05> laipto apdaila viršutinė d.p. siauras kantas 50mm	
5009960	Scania R 05> laipto apdaila viršutinė k.p. siauras kantas 50mm	
5009348	Scania R 05> laipto apdaila apatinė d.p.	
5009347	Scania R 05> laipto apdaila apatinė k.p.	
5008190	Scania R 05> laipto apdaila vidurinė d.p.	
5002239	Scania R 05> laipto apdaila vidurinė k.p.	

1535039	Scania R 05> pakoja viršutinė d.p.	
1535040	Scania R 05> pakoja viršutinė k.p.	
5009975	Scania R 05> pakoja viršutinė d.p.	
5009977	Scania R 05> pakoja viršutinė k.p.	
5009964	Scania R 05> pakoja vidurinė k=d	
5008140	Scania R 05> pakoja apatinė k=d	
1536807	Scania R 05> apatinės grotelės	
5009972	Scania R 05> viršutinės grotelės į apatines groteles	
1459143	Scania R 05> apatinės grotelės į apatines groteles	
1748086	Scania P 05> grotelių rėmas po kapotu	
1459145	Scania R 05> grotelės po kapotu	
1543607	Scania P 05> kapotas	

1459135	Scania R 05> grotelės į kapotą apatinės	
1459134	Scania R 05> grotelės į kapotą vidurinės	
1466032	Scania R 05> grotelės į kapotą kampinės d.p.	
1466031	Scania R 05> grotelės į kapotą kampinės k.p.	
1904814	Scania P 05> kapoto rėmas	
1543609	Scania P 05> kabinos kampo apdaila d.p.	
1543608	Scania P 05> kabinos kampo apdaila k.p.	
1496294	Scania P 05> kabinos kampo vid.dalis d.p.	
1496293	Scania P 05> kabinos kampo vid.dalis k.p.	
5003178	Scania 4 96> durų rankenėlė d.p.	
5003177	Scania 4 96> durų rankenėlė k.p.	
5003688	Scania 4 96> durų rankenėlės šerdis su rakteliu	

5009953	Scania 4/P/R/G dangtelis vyro ant kėbulo d.p.	
5009953	Scania 4/P/R/G dangtelis vyro ant kėbulo k.p.	
5009955	Scania 4/P/R/G dangtelis vyro ant durų d.p.	
5009956	Scania 4/P/R/G dangtelis vyro ant durų k.p.	
5009962	Scania R 05> laipto korpusas d.p.	
5009963	Scania R 05> laipto korpusas k.p.	
1426110	Scania R 05> laipto korpuso kronšteinas d.p.	
1426109	Scania R 05> laipto korpuso kronšteinas k.p.	

5009947	Scania R 05> priekinio posparnio galinė apdaila d.p. 415mm aukštis	
5009948	Scania R 05> priekinio posparnio galinė apdaila k.p. 415mm aukštis	
5009967	Scania R 05> priekinio posparnio galinė apdaila d.p. 350mm aukštis	
5009968	Scania R 05> priekinio posparnio galinė apdaila k.p. 350mm aukštis	
5009949	Laikiklis Scania 4/P/R/G/2010 priekio sparno d/k	
5009965	Scania R 05> priekinio posparnio priekinė apdaila d.p. 165mm aukštis	
5009966	Scania R 05> priekinio posparnio priekinė apdaila k.p.	
5005582	Scania 4 96> kabinos posparnis priekinis d.p. galinis k.p.	
5006028	Scania 4 96> kabinos posparnis priekinis k.p. galinis d.p.	
0000582	Scania 4 96> akumuliatoriaus dangtis	
5008260	Scania 4 96> saulės skydelio skaidri dalis	

1539870	Scania 4 96> saulės skydelio viršutinė dalis su skylė priešrūkiniui	
1539871	Scania 4 96> saulės skydelio viršutinė dalis be skylės priešrūkiniam	
1326953	Scania 4 96> dangtelis į saulės skydelį	
5003390	Scania 4 96> žibintas į saulės skydelį	
5003496	Scania 4 96> galinio sparno išorinė k.p.=vidinė d.p.	
5001801	dalis Scania 4 96> galinio sparno išorinė d.p.=vidinė k.p. dalis	
5003967	Scania 4 96> galinio sparno viršutinė dalis	
5005599	Scania 4 96> galinio sparno viršutinė dalis autovežiui	
5009969	Scania 4 96> laikiklis žibintui	
5009498	Scania 4 96> sparno laikiklio skarda	

5009499	Scania 4 96> sparno laikiklio skarda	
4000792	Scania R 05> galinio sparno kronšteinas d.p.	
4000793	Scania R 05> galinio sparno kronšteinas k.p.	
4001444	Scania R 05> priekinio sparno kronšteinas d.p.	
4001445	Scania R 05> priekinio sparno kronšteinas k.p.	
5005276	Laikiklis sparnui galinis d.p. M16*2,0 Scania	
5008575	Laikiklis sparnui galinis k.p. M16*2,0 Scania	
4002324	Kronšteinas laikiklio sparno tvirtinimo SC	









5008645	Įvorė laikiklio sparno SC	
5003687	Scania 4 96> galinio sparno guminis laikiklis	
5003306	Bako kamštis SCANIA su užraktu	
5005050 5009684	Scania 4 96> išsiplėtimo bakelis	

SCANIA P/R 2010>



`5001097 4001188	Scania 4 09/95>09/04 priekinis žibintas d.p.	
5001421 4001189	Scania 4 09/95>09/04 priekinis žibintas k.p.	
5002800	Scania 4 09/95>09/04 priekinio žibinto stiklas d.p.	
5002057 5008144	Scania 4 09/95>09/04 priekinio žibinto stiklas k.p.	

5001442 4001081	Scania 4 09/95>09/04 posūkis d.p.	
5001444 4001011	Scania 4 09/95>09/04 posūkis k.p.	
5005373	Lizdas, posūkio SC-124	
5005882	Scania R/P/T 05> priekinis žibintas Xenon d.p.	
5005883	Scania R/P/T 05> priekinis žibintas Xenon k.p.	
5005720	Scania R/P/T 05> priekinio žibinto stiklas Xenon d.p.	
5005719	Scania R/P/T 05> priekinio žibinto stiklas Xenon k.p.	
5003742	Scania R/P/T 05> posūkis d=k	
5003090	Scania P/R/T 03/04> tolimų šviesų žibintas d.p.	
5003091	Scania P/R/T 03/04> tolimų šviesų žibintas k.p.	

5002879	Scania P/R/T 03/04> priešrūkinis žibintas d.p.	
5001334	Scania P/R/T 03/04> priešrūkinis žibintas k.p.	
5006055	Scania P/R/T 03/04> žibintas DRL d.p.	
4000643	Scania P/R/T 03/04> žibintas DRL d.p.	
5005681	Atšvaitas Scania	
5005879	Žib.atšvaitas MD-10 Scania su lizdu į laipto vidurinę apdailą	
5003200	Žib.diodinis LP-10 SCANIA (3LED)	
5004887	Scania R/P/T 05> posūkis d=k	







5005717	Scania R 05> žibintas diodinis į saulės skydelį	
4000156 (su laidu)		
5009768	Scania R 05> priešrūkinio žibinto rėmelis d.p.	
5009771	Scania R 05> priešrūkinio žibinto rėmelis k.p.	
5008867	Buferio kampas Scania P 2010 362mm aukštis d.p.	
5008868	Buferio kampas Scania P 2010 362mm aukštis k.p.	
5008866	Buferio vidurys Scania P 2010 362mm kampui	
5009928	Tinklelis Scania P 2010 362mm aukščiui	
5007865	Buferio kampas Scania R 2010 480mm aukštis d.p. plotis 1020mm	
5007866	Buferio kampas Scania R 2010 480mm aukštis k.p. plotis 1020mm	

5009950	Buferio kampas Scania R 2010 480mm aukštis d.p. plotis 11400mm	
5009951	Buferio kampas Scania R 2010 480mm aukštis k.p. plotis 1140mm	
5007822	Buferio vidurys Scania R 2010 480mm kampui	
5006957	Scania R 05> žibinto korpuso II dalis d.p.	
5006968	Scania R 05> žibinto korpuso II dalis k.p.	
5008869	Scania R 05> žib.korpuso virš.dalis (R/T kab) d.p.	
5008870	Scania R 05> žib.korpuso virš.dalis (R/T kab) k.p.	
5008871	Scania P 05> žib.korpuso virš.žema kabina d.p.	
5008872	Scania P 05> žib.korpuso virš.dalis žema kabina k.p.	

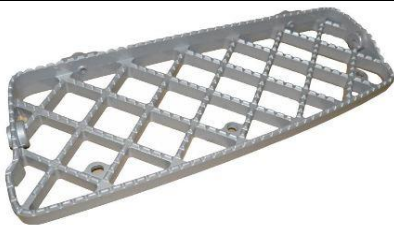
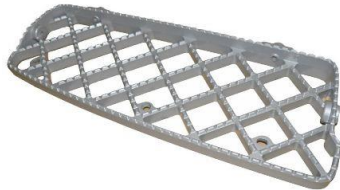
5008862	Scania R 05> kabinos kampo apdaila d.p.	
5008863	Scania R 05> kabinos kampo apdaila k.p.	
5008864	Scania R 05> kabinos kampo vidinė dalis d.p.	
5008865	Scania R 05> kabinos kampo vidinė dalis k.p.	
5009927	Scania R 2010 apatinės grotelės 330mm aukštis	
5009952	Scania R 2010 apatinės grotelės 380mm aukštis	
5003178	Scania 4 96> durų rankenėlė d.p.	
5003177	Scania 4 96> durų rankenėlė k.p.	
5003688	Scania 4 96> durų rankenėlės šerdis su rakteliu	

5009953	Scania 4/P/R/G dangtelis vyro ant kėbulo d.p.	
5009953	Scania 4/P/R/G dangtelis vyro ant kėbulo k.p.	
5009955	Scania 4/P/R/G dangtelis vyro ant durų d.p.	
5009956	Scania 4/P/R/G dangtelis vyro ant durų k.p.	
5009962	Scania R 05> laipto korpusas d.p.	
5009963	Scania R 05> laipto korpusas k.p.	
5009976	Scania R 05> laipto apdaila viršutinė d.p. platus kantas 100mm	

5009961	Scania R 05> laipto apdaila viršutinė k.p. platus kantas 100mm	
5009959	Scania R 05> laipto apdaila viršutinė d.p. siauras kantas 50mm	
5009960	Scania R 05> laipto apdaila viršutinė k.p. siauras kantas 50mm	
5000292	Apdaila laiptelio šoninė d.p. Scania 2010 P / R	
5008190	Scania R 05> laipto apdaila vidurinė d.p. NAUJO TIPO	
5002239	Scania R 05> laipto apdaila vidurinė k.p. NAUJO TIPO	
5009348	Scania R 05> R10> laipto apdaila apatinė d.p.	
5009347	Scania R 05> R10> laipto apdaila apatinė k.p.	
5008140	Scania R 05> pakoja apatinė k=d	
5009964	Scania R 05> pakoja vidurinė k=d	

5009975	Scania R 05> pakoja viršutinė d.p.	
5009977	Scania R 05> pakoja viršutinė k.p.	
5007221	Scania 4 96> kabinos posparnio išorinė dalis d.p. 100mm aukštis	
5007222	Scania 4 96> kabinos posparnio išorinė dalis k.p. 100mm aukštis	
5009965	Scania R 05> priekinio posparnio priekinė apdaila d.p. 165mm aukštis	
5009966	Scania R 05> priekinio posparnio priekinė apdaila k.p. 165mm aukštis	
5009947	Scania R 05> priekinio posparnio galinė apdaila d.p. 415mm aukštis	
5009948	Scania R 05> priekinio posparnio galinė apdaila k.p. 415mm aukštis	

5009967	Scania R 05> priekinio posparnio galinė apdaila d.p. 350mm aukštis	
5009968	Scania R 05> priekinio posparnio galinė apdaila k.p. 350mm aukštis	
5009949	Laikiklis Scania 4/P/R/G/2010 priekio sparno d/k	
5003687	Scania 4 96> galinio sparno guminis laikiklis	
5005595	Scania 4 96> galinio sparno metalinis laikiklis	
5003967	Scania 4 96> galinio sparno viršutinė dalis	
5005599	Scania 4 96> galinio sparno viršutinė dalis autovežiui	
5009969	Scania 4 96> laikiklis žibintui	

5003496	Scania 4 96> galinio sparno išorinė k.p.=vidinė d.p.	
5001801	dalis Scania 4 96> galinio sparno išorinė d.p.=vidinė k.p. dalis	
5009498	Scania 4 96> sparno laikiklio skarda	
5009499	Scania 4 96> sparno laikiklio skarda	
4000792	Scania R 05> galinio sparno kronšteinas d.p.	
4000793	Scania R 05> galinio sparno kronšteinas k.p.	
5005276	Laikiklis sparnui galinis d.p. M16*2,0 Scania	

5008575	Laikiklis sparnui galinis k.p. M16*2,0 Scania	
4002324	Kronšteinas laikiklio sparno tvirtinimo SC	
5008645	Įvorė laikiklio sparno SC	